

ADDENDUM NO. 1

April 7, 2017

PROJECT: Town Line Road Culvert
BID DATE: April 13, 2017 at 2:00 PM
FROM: David Conger, DuBois& King, Inc., Project Manager

To Prospective Bidders and Interested Parties

This addendum forms a part of the bidding documents and will be incorporated into the Contract Documents, as applicable. Insofar as the original Contract Documents, Specifications, and Drawings are inconsistent, this Addendum shall govern. Please acknowledge receipt of this Addendum on both copy of the Bid Form submitted to the Town of Mendon. **FAILURE TO ACKNOWLEDGE RECEIPT OF ADDENDUM ON THE BID FORM MAY BE CAUSE FOR DISQUALIFICATION.**

PRE-BID QUESTIONS

1. Is there a start date set for the closure of Town Line Road? **RESPONSE: No road closure date has been set by the Town. This will need to be scheduled by the contractor with at least two weeks written notification to the Town beforehand.**
2. Is a bid guarantee required? What is required for the bid guarantee? Is there a specific form for the bid bond? **RESPONSE: A bid bond or certified check for no less than 5% of the bid amount is required. There is no specific bid bond form required.**

CONTRACT DOCUMENTS:

1. See attached Contractor's EEO Certification Form and Debarment and Non-Collusion Affidavit.

SPECIFICATIONS:

No change.

CONSTRUCTION DRAWINGS:

1. See attached Drawing C-9, Rev. 1 04/07/2017 Addendum 1
 - a. Modified height and baffle dimension of the box culvert.
 - b. Provided dimension for cut off wall.

END OF ADDENDUM NO. 1

APPENDIX A

STATE OF VERMONT
AGENCY OF TRANSPORTATION

November, 1985
CA-109

CONTRACTOR'S EEO CERTIFICATION FORM

Certification with regard to the Performance of Previous Contracts of Subcontracts subject to the Equal Opportunity Clause and the filing of Required Reports.

The bidder _____, proposed subcontractor _____, hereby certifies that he/she has _____, has not _____, participated in a previous contract or subcontract subject to the equal opportunity clause, as required by Executive Orders 10925, 11114, or 11246 as amended, and that he/she has _____, has not _____, filed with the Joint Reporting Committee, the Director of the Office of Federal Contract Compliance, a Federal Government contracting or administering agency, or the President's Committee on Equal Employment Opportunity, all reports due under the applicable filing requirements.

Company	By	Title
---------	----	-------

NOTE: The above certification is required by the Equal Employment Opportunity regulations of the Secretary of Labor (41 CFR 60-1.7(b) (1)), and must be submitted by bidders and proposed subcontractors only in connection with contracts and subcontracts which are subject to the equal opportunity clause. Contracts and subcontracts which are exempt from the equal opportunity clause are set forth in 41 CFR 60-1.5 (Generally only contracts or subcontracts of \$10,000 or under are exempt.) Currently, Standard Form 100 (EEO-1) is the only report required by the Executive Orders or their implementing regulations.

Proposed prime contractors and subcontractors who have participated in a previous contract or subcontract subject to the Executive Orders and have not filed the required reports should note that 41 CFR 60-1.7 (b) (1) prevents the award of contracts and subcontracts unless such contractor submits a report covering the delinquent period or such other period specified by the Federal Highway Administration, or by the Director, Office of Federal Contract Compliance, U.S. Department of Labor.

APPENDIX B

CA-91

STATE OF VERMONT
AGENCY OF TRANSPORTATION
DEBARMENT AND NON-COLLUSION AFFIDAVIT

I, _____, representing
(Official Authorized to Sign Contracts)
_____ of _____,
(Individual, Partnership or Corporation) (City or State)

being duly sworn, depose and certify under the penalties of perjury under the laws of the State of Vermont and the United States that on behalf of the person, firm, association, or corporation submitting the bid certifying that such person, firm, association, or corporation has not, either directly or indirectly, entered into any agreement, participated in any collusion, or otherwise taken any action, in restraint of free competitive bidding in connection with the submitted bid for the Vermont project:

(Project Name)
_____ project located on _____,
(Project Number) (Route or Highway)
bids opened at _____,
(Town or City)

Vermont on _____, 20__.
(Date)

I further depose and certify under the penalties of perjury under the laws of the State of Vermont and the United States that except as noted below said individual, partnership or corporation or any person associated therewith in any capacity is not currently, and has not been within the past three (3) years, suspended, debarred, voluntarily excluded or determined ineligible by any Federal or State Agency; does not have a proposed suspension, debarment, voluntary exclusion or ineligibility determination pending; and has not been indicted, convicted, or had a civil judgement rendered against (it, him, her, them) by a court having jurisdiction in any matter involving fraud or official misconduct within the past three (3) years.

Exceptions: ____ No ____ Yes. (If yes complete back of this form.)

Sworn to before me this

____ day of _____, 20__

(Name of Individual, Partnership or Corporation) L.S.

(Signature of Official Authorized to Sign Contracts) L.S.

(Notary Public)

(Name of Individual Signing Affidavit) L.S.

(My commission expires _____)

(Title of Individual Signing Affidavit) L.S.

APPENDIX B

Exceptions will not necessarily result in denial of award, but will be considered in determining bidder responsibility. For any exception noted, indicate below to whom it applies, initiating agency, and dates of action. Providing false information may result in criminal prosecution or administration sanctions.

EXCEPTIONS:

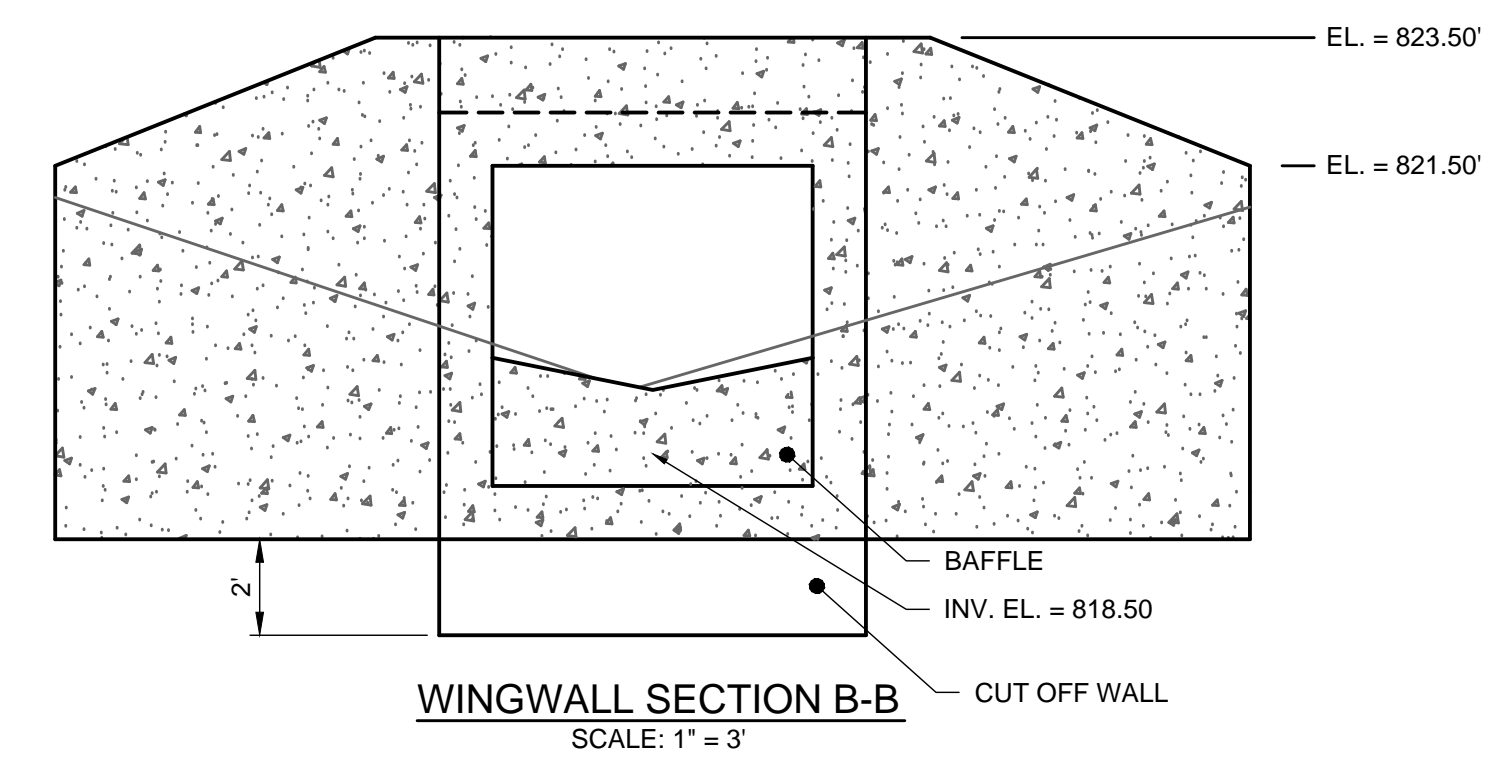
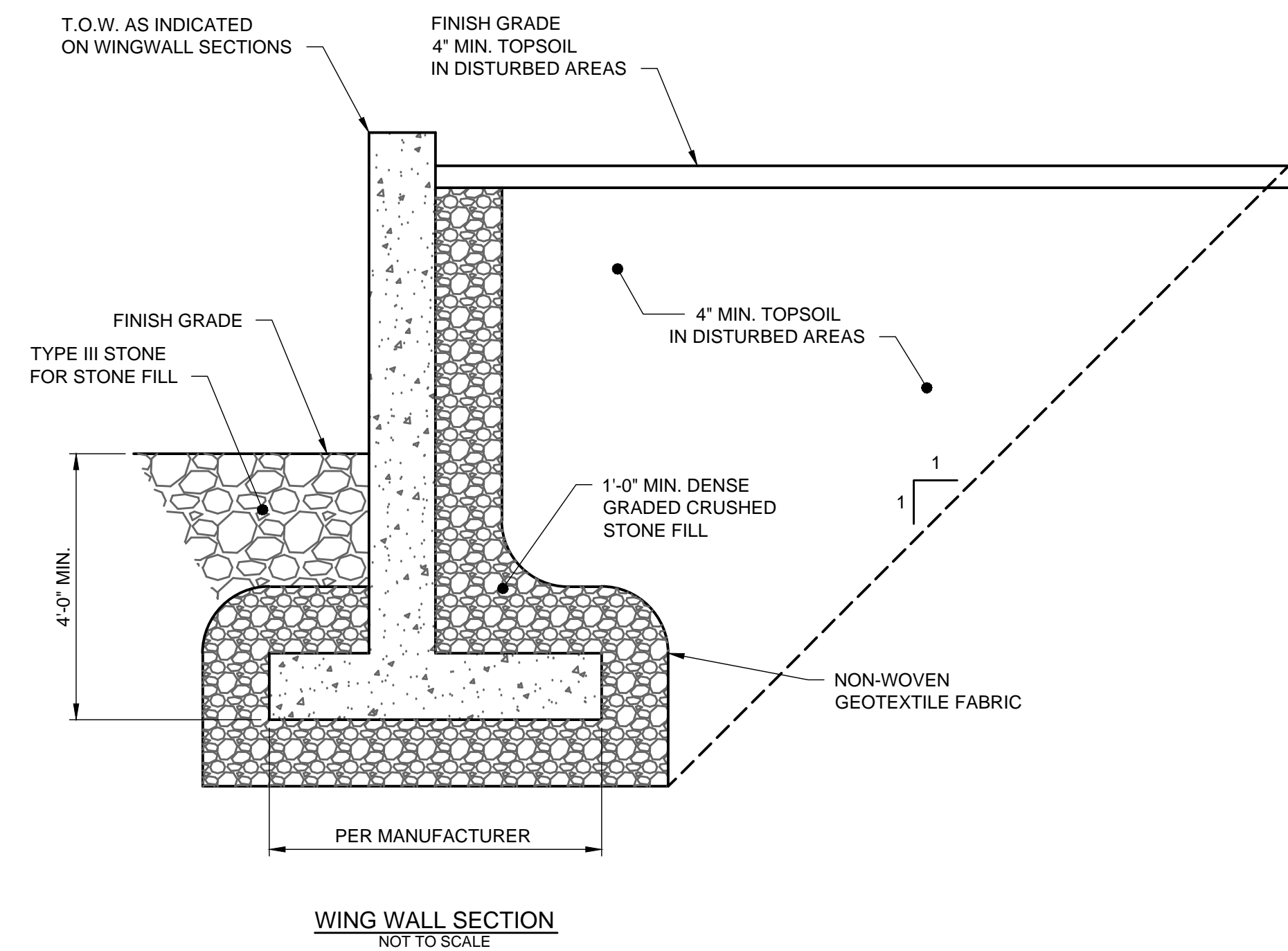
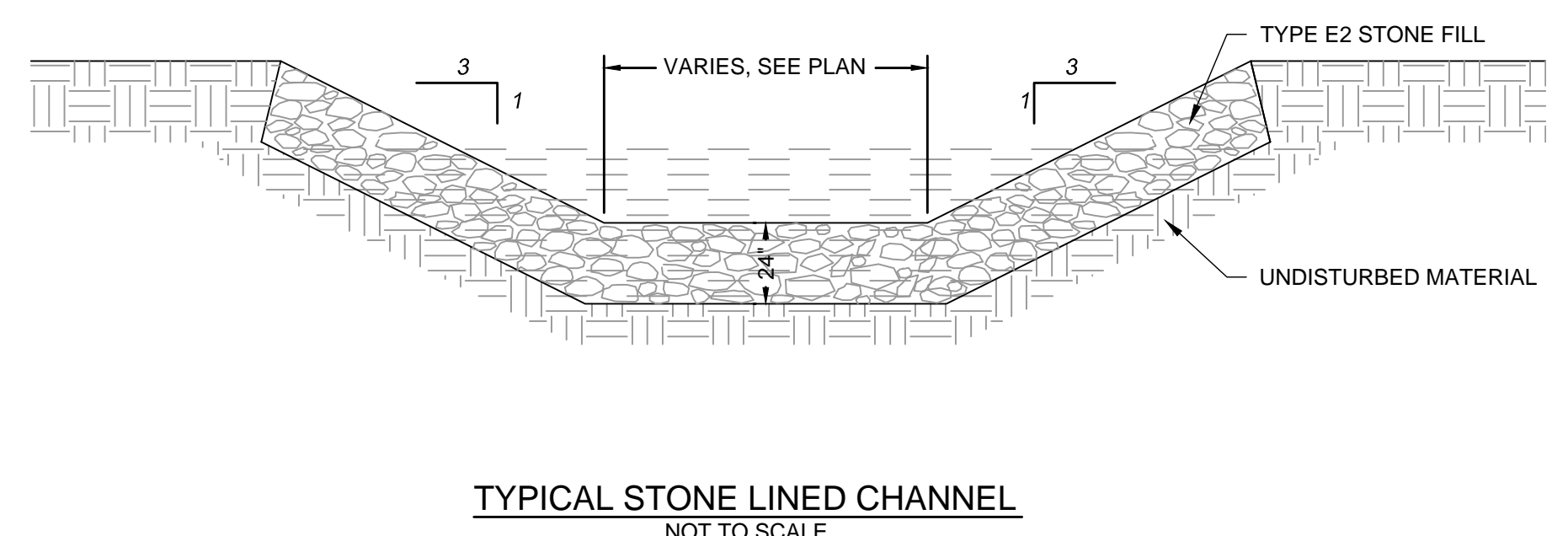
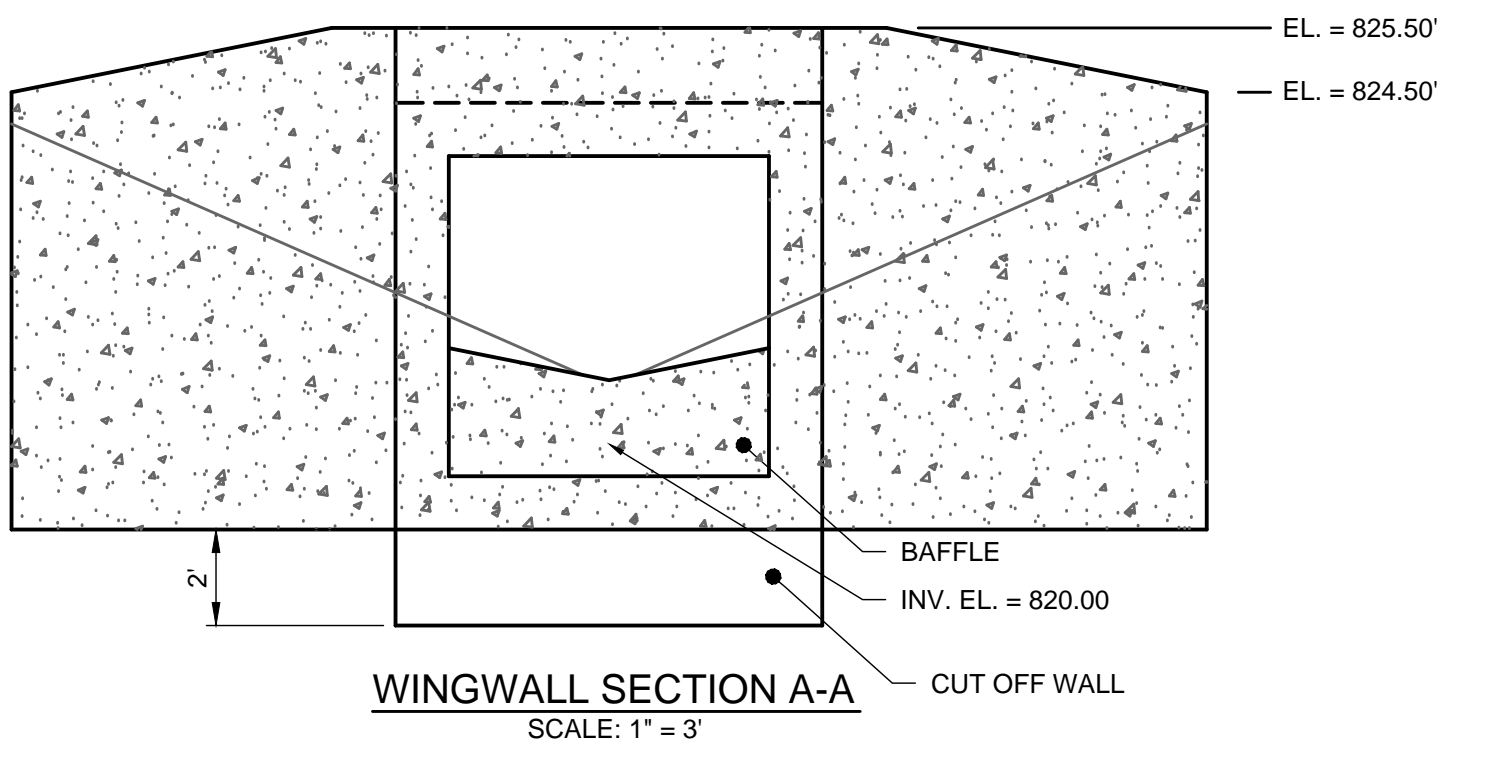
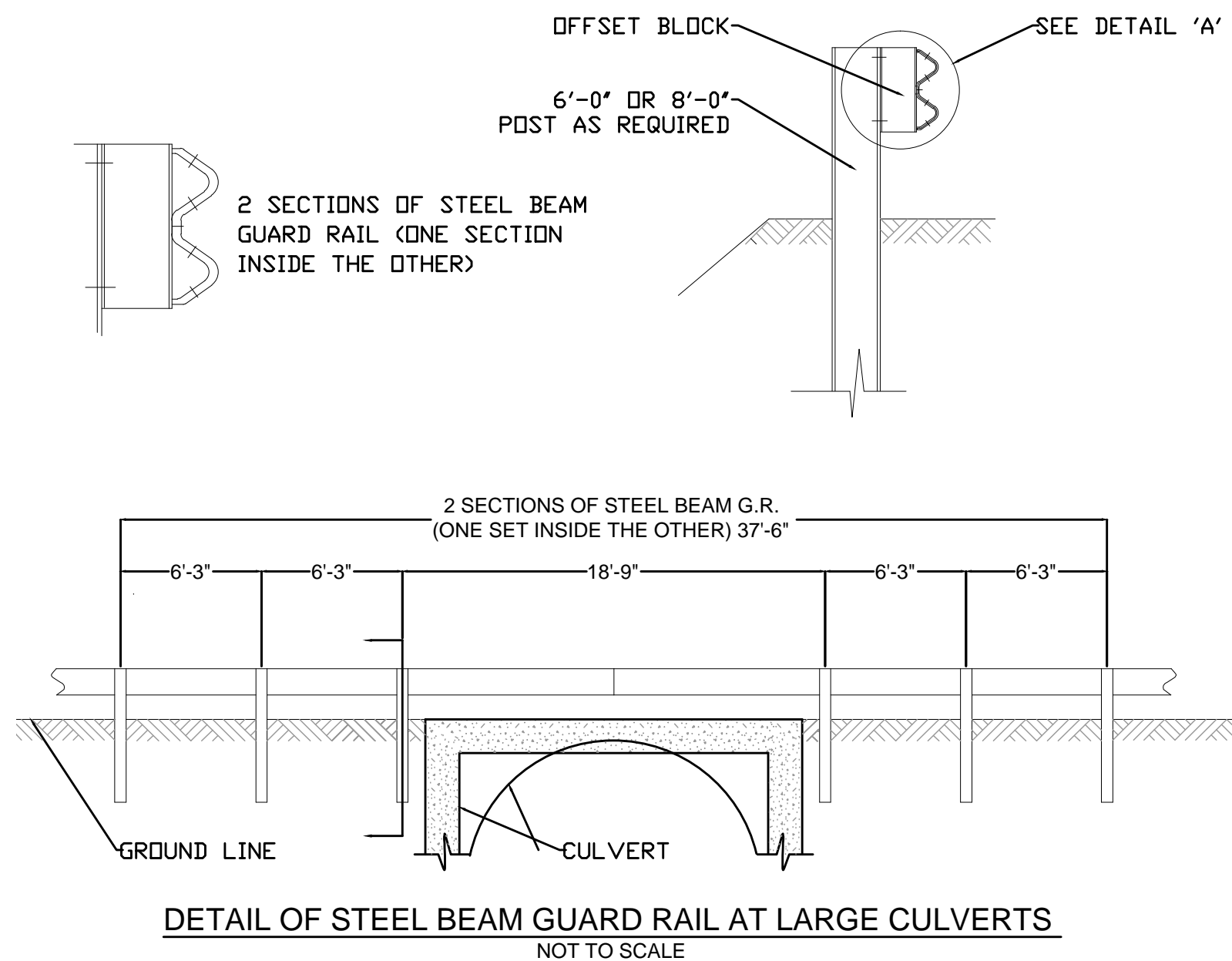
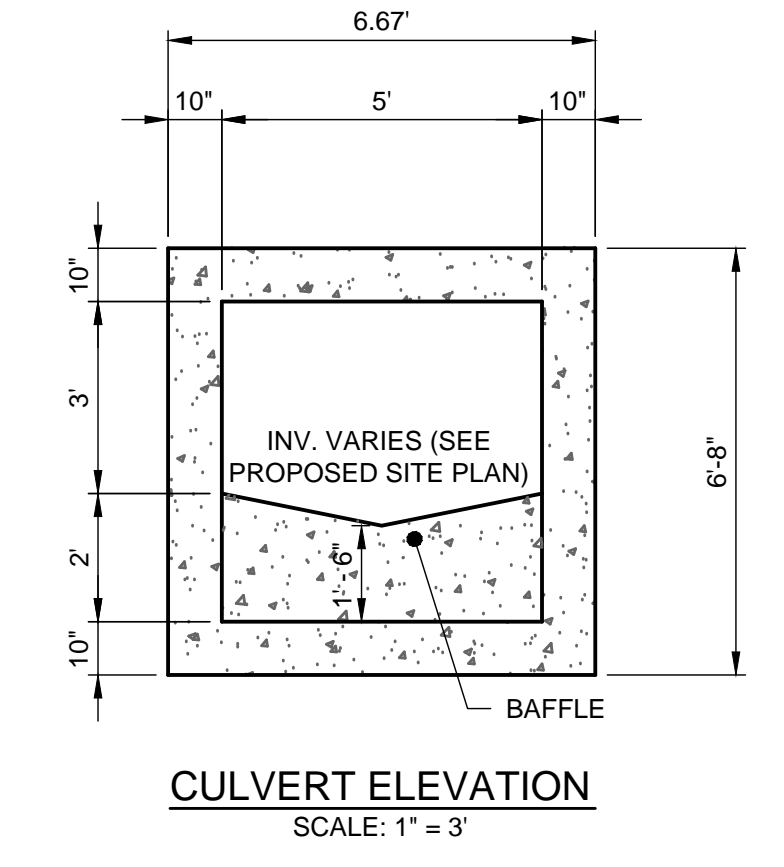
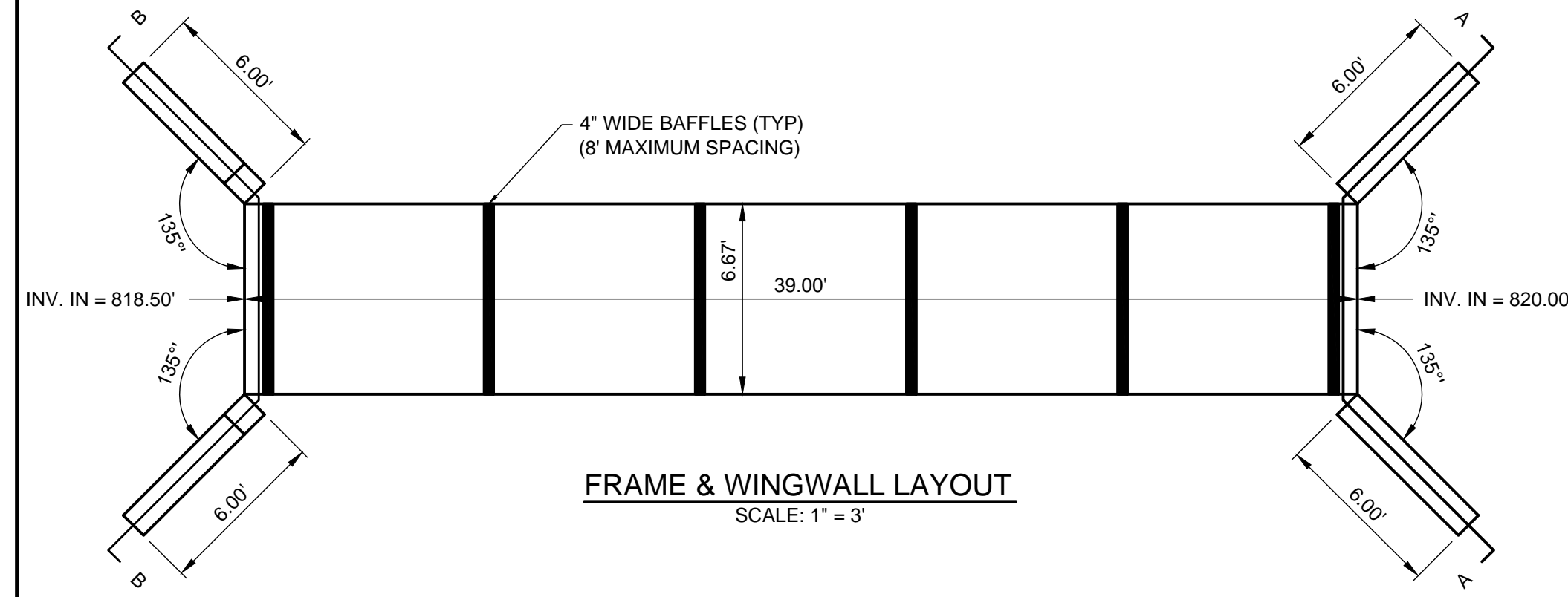
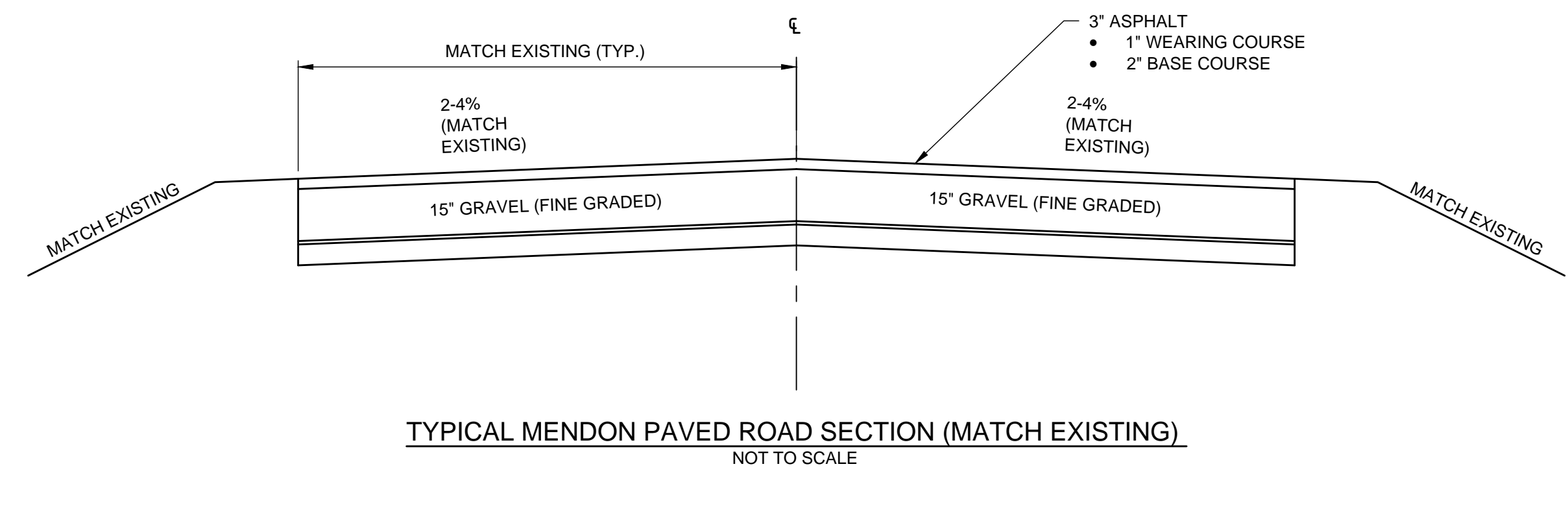
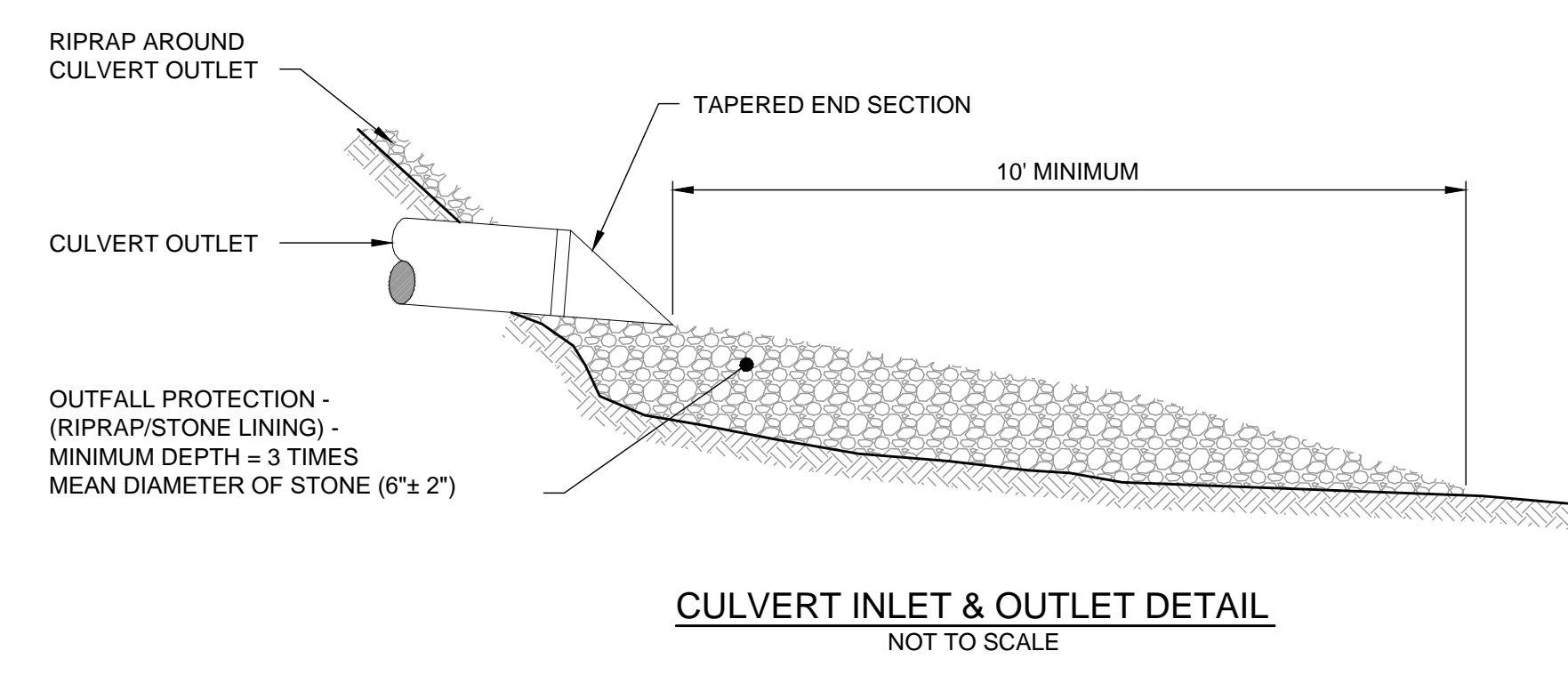
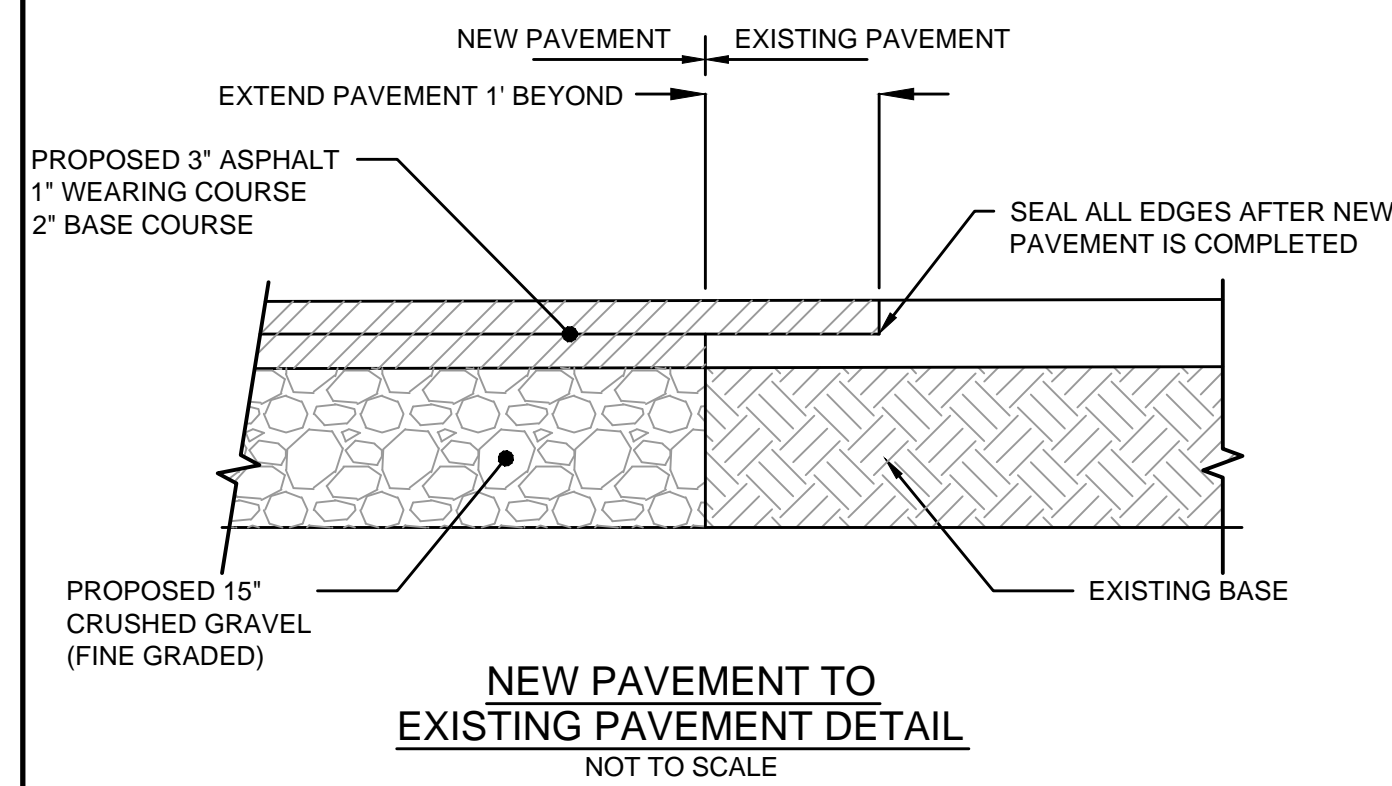

NOTES:

- STREAMBED STONE FILL SPECIFICATION. TYPE E2:** THE LONGEST DIMENSION OF THE STONE SHALL BE AT LEAST 24", AND AT LEAST 50 PERCENT OF THE VOLUME OF THE STONE IN PLACE SHALL HAVE A LEAST DIMENSION OF 18 INCHES, AND AT LEAST 25 PERCENT OF THE PARTICLES SHALL HAVE A MAXIMUM DIMENSION OF 2 INCHES AND BE WELL GRADED MATERIAL.
 - THE STREAMBED STONE FILL SHALL BE HARD, BLASTED, ANGULAR ROCK OTHER THAN SERPENTINE ROCK CONTAINING THE FIBROUS VARIETY CHRYSOTILE (ASBESTOS). SIMILAR SIZE RIVER SEDIMENT IS AN ACCEPTABLE ALTERNATIVE AS IS A MIXTURE OF ANGULAR MATERIAL AND RIVER SEDIMENT.
 - STONE PLACED INSIDE OF A CLOSED STRUCTURE SHALL BE PLACED SUCH THAT THE STRUCTURE IS NOT DAMAGED.
 - CARE SHALL BE TAKEN TO LIMIT SEGREGATION OF THE MATERIALS.
 - ADD SAND BORROW ITEM AS NEEDED TO SEAL THE BED AND PREVENT SUBSURFACE FLOW.
 - THERE SHALL BE NO SUBSURFACE FLOW UPON FINAL INSPECTION.
- STONE SHALL BE A WELL GRADED MIXTURE DEFINED AS A MIXTURE MEETING ABOVE STONE SPECIFICATION AND COMPOSED PRIMARILY OF THE LARGER STONE SIZES, BUT WITH A SUFFICIENT MIXTURE OF OTHER SIZES TO FILL THE PROGRESSIVELY SMALLER VOIDS BETWEEN STONES.
- STONE SHALL BE APPROVED, ROUGH, BROKEN, QUARRY STONE WITH IRREGULAR FACES PERMITTING PLACEMENT IN A TIGHT INTERLOCKING MANNER WITH SMALLER STONES FILLING VOIDS BETWEEN LARGER STONES. THE STONES SHALL BE HARD, SOUND, RESISTANT TO WATER ACTION, WEATHERING AND SUITABLE FOR PURPOSE INTENDED.

NOTES:

- CONTRACTOR SHALL SUBMIT A STRUCTURAL DESIGN (SHOP DRAWINGS AND CALCULATIONS) FOR WING WALLS STAMPED AND SIGNED BY A VERMONT REGISTERED PROFESSIONAL STRUCTURAL ENGINEER FOR REVIEW AND APPROVAL.

DuBois & King Inc.
 ENGINEERING • PLANNING •
 MANAGEMENT • DEVELOPMENT
 6 GREEN TREE DRIVE
 SO. BURLINGTON, VT 05403
 TEL: (802) 878-7661
 FAX: (866) 783-7101
 www.dubois-king.com
 BRANDON, VT
 SPRINGFIELD, VT
 BEDFORD, NH
 LACONIA, NH
 © Copyright 2017 Dubois & King Inc.

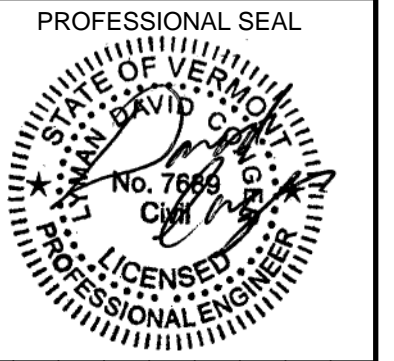

NO.	DATE	BY	DESCRIPTION
1	04/07/17	LDC	ADDENDUM NO. 1



TOWN LINE ROAD
 CULVERT
 REPLACEMENT
 PROJECT
 MENDON, VT

SHEET TITLE
 CIVIL DETAILS

DRAWN BY TJD	DATE MAR. 27, 2017
CHECKED BY LDC	D&K PROJECT # 423622P1
PROJ. ENG. LDC	D&K ARCHIVE #

SHEET NUMBER
C-9

I:\423622P1\Mendon Town Line Road Culvert Replacement\dwg\423622-Dets.dwg 4/7/2017 2:38 PM